

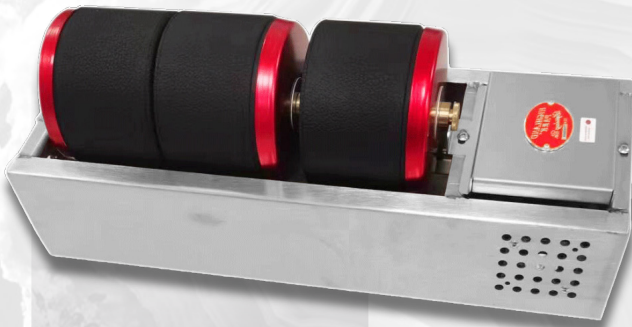

# MODEL RT3L

## ROTARY TUMBLER



**MODEL RT3L**  
3 1.5 lb. Barrels

**MODEL RT3L**  
2-3 Barrels

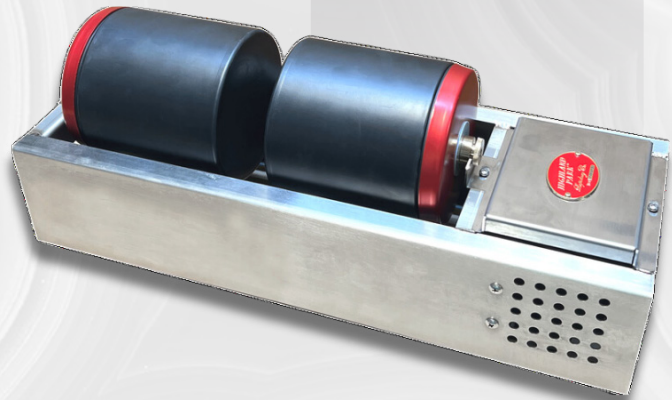

**Caution:** Read and Understand all Safety and Operating Instructions before using this equipment

# Introduction

---

Let's get tumbling! Thank you for selecting the Highland Park Lapidary Model RT3L Rotary Tumbler with either TWO 3 lb. barrels or THREE 1.5 lb. barrels. Our dedicated team is confident that you will be pleased with your purchase. Highland Park Lapidary takes pride in producing top quality, highly dependable products for both hobby and commercial lapidary users throughout the world.

Operated correctly, your Model RT3L Rotary Tumbler will provide you with years of quality service, and buckets of shiny stones. To help familiarize you with the features, maintenance and safe operation of the machine, we have included this owner's manual. Please take the time to acquaint yourself with the Model RT3L Rotary Tumbler by reading and understanding this manual.

If you have questions concerning your Model RT3L Rotary Tumbler, our customer service staff is waiting to help you - call 512-348-8528.

# Table Of Contents

---

<b>Product Safety</b> .....	1
<b>Machine Specifications</b> .....	2
<b>Setting Up Your Tumbler</b> .....	2
Unpacking.....	3
Test Run Your Machine.....	3
<b>Process Steps</b> .....	4
Loading The Barrel.....	4
<b>Maintaining Your Tumbler</b> .....	6
<b>Rock Tumbling Checklist</b> .....	8
<b>A Quick Look At Rock Hardness</b> .....	9
<b>Rock Tumbling Chart</b> .....	10
<b>Tumbler Speed</b> .....	10
Using The Tachometer.....	10
<b>Common Tumbling Problems</b> .....	11
I Followed All The Steps, And My Rocks Are Still Hazy!.....	11
My Edges (Or Centers, Or Indents) Won't Polish!.....	11
My Stones Are Breaking In The Machine.....	11
My Stones Are Scratched!.....	12
<b>Warranty Coverage</b> .....	13
<b>Exploded Views</b> .....	14
RT3L 3LB Barrel Assembly.....	14
RT3L 1.5LB Barrel Assembly.....	14
Main Component.....	16
Screws & Fasteners.....	17
<b>Troubleshooting</b> .....	18

# Safety Precautions

All electrical equipment carries some risk. To minimize danger to either yourself or the machine, please read and follow all safety, operating and maintenance instructions!

Failure to read, understand and follow these instructions could result in injury or death to you or others, result in damage and/or reduced equipment life.

**NEVER OPERATE MACHINE WITH GUARDS REMOVED** Never operate the machine without the guards in place to prevent personal injury or damage to the machine.

## CONNECTING AND DISCONNECTING POWER

- **DISCONNECTING** Always disconnect the machine before servicing.
- **CONNECTING** – Plug the power supply into the tumbler and then into the wall.

The tumbler will start to rotate once the power switch is turned on. Older models will start as soon as the power is plugged in.

## ELECTRICAL SAFETY

- If the wiring becomes damaged or frayed, **replace it immediately.**
- If using an extension cord, it should be no longer than 6 feet and at least 18 gauge wire.
- Use this tool only with the proper power source 120V/220V 50/60 Hz.
- Do not allow water to come in contact with electrical components, and do not connect or disconnect the power with wet hands.
- Disconnect the power before servicing the machine.

**ROTATING OR MOVING PARTS** Keep hair and clothing away from the rotating shafts to prevent injury. Never operate the machine with covers or guards removed.

## KEEP WORK AREA CLEAN

- Cluttered work areas invite accidents. Keep your work area clean and organized.
- Never use the tumbler in damp or wet locations nor expose it to rain. Always keep your work area well lighted.

## WORK METHOD

- **DO NOT OVERLOAD THE TUMBLER BARREL** Good results cannot be achieved if the barrel is improperly loaded, as stones need room to tumble..

## MAINTAINING THE MACHINE

- **CHECK FOR DAMAGED OR WORN PARTS** Before using the machine, check for damaged parts or wires. ANY part that is damaged or worn should be replaced. Regularly check moving parts for proper alignment, and to make sure nothing is binding.

**WARNING:** Although the RT3L Tumbler Motor is capable of running at speeds higher than 70 RPM, running it at maximum speed can damage the bushings, requiring replacement of the bushings.

# Specifications

---

<b>Tumbler Model</b>	Model RT3L
<b>Machine Weight</b>	7.64 lbs.

---

## BARREL SIZE

Model RT3L 2-3lb Rotary Tumbler: two 3 lb. barrel assemblies

Model RT3L 3-1.5lb Rotary Tumbler: three 1.5lb barrel assemblies.

# Setting Up Your Tumbler

The Highland Park Model RT3L Rotary Tumbler has been carefully packaged for protection during its trip from the factory to you. The machine has been tested to ensure that it's operating properly and that all components meet specifications. You should have the following when you unpack your unit:

### If you have the Model RT3L 2-3lb:

- Highland Park Model RT3L Rotary Tumbler
- 3 lb. Barrel Assembly (Qty 2)
- Power Adapter Unit

### If you have the Model RT3L 3-1.5lb:

- Highland Park Model RT3L Rotary Tumbler

- 1.5 lb. Barrel Assembly (Qty 3)
  - Power Adapter Unit
- TOOLS NEEDED**
- #2 Phillips Screwdriver

### UNPACKING THE MACHINE:

The Model RT3L 3 lb. is packaged carefully to be a snug fit in the foam packing, so when lifting the machine out of the box, grip the Tumbler by the frame. Do not lift it out of the box using the barrel shafts, which may dislodge the bearings and cause the barrel to track poorly. If this does happen, a solution is available under TROUBLESHOOTING at the end of this manual.

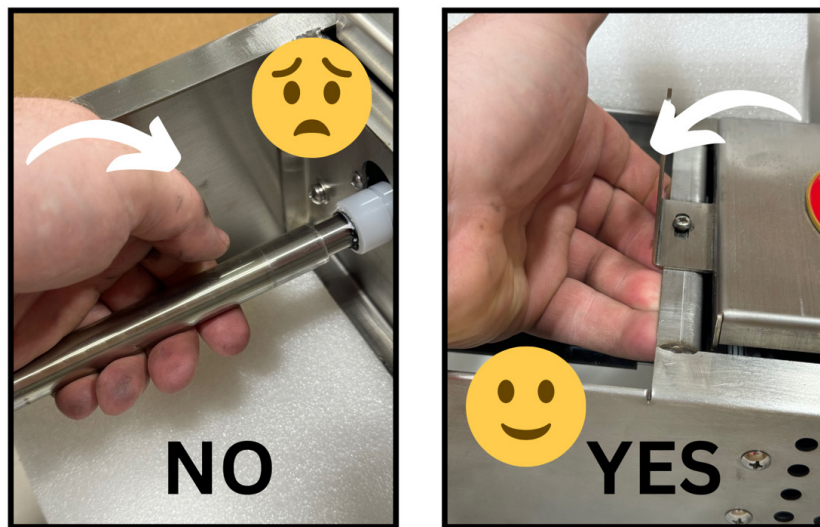

Your Highland Park Model RT3L 3 lb. Rotary Tumbler has been shipped from the factory thoroughly tested and inspected. Choose a place in your workspace for your tumbler that allows an adequate working space and has a convenient power outlet. Avoid using an extension cord if possible; it's much safer to connect the machine directly to a wall power outlet.

Place the Model RT3L 2-3 lb. or 3-1.5 lb. Rotary Tumbler on a flat, level surface.

### Test Run your Machine:

- Connect the machine to the power outlet:
- Plug the power adapter into the machine.
- Plug the power adapter into the wall outlet.
- Turn on the power switch
- There will be about a 5 second delay as the controller initializes before the machine starts turning the barrel shafts. (On units that include a power switch, use the power switch to turn the machine on and off)
- Adjust the speed knob so shafts are turning. (See adjusting speed section before attempting to run the tumbler.)

# Process Steps

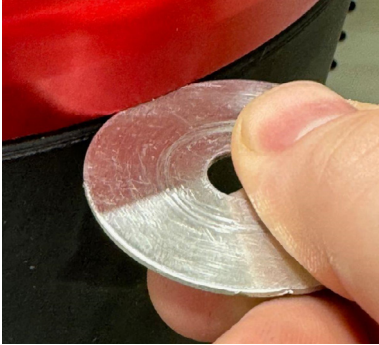

## LOADING THE BARREL:

1. **To open the barrel**, unscrew and remove the brass nut on the lid, and then use the washer to pry between the lid and the barrel. Pry gently around the edge of the lid until it can be removed easily by hand.
2. **Use your thumb** to pull the edge of the barrel away from the inner lid, going around the whole edge of the barrel. The rubber will stick together a little after the barrel has been closed. Pulling the rubber away slightly will make it easier to grip the center bolt and pull the inner lid out of the barrel.

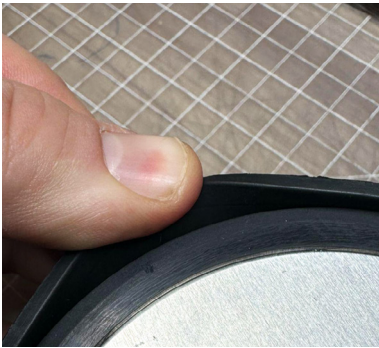

3. **Add rock to the barrel:** Fill the barrel approximately 3/4 full of small stones of assorted sizes. (approx. 3 lbs. in each 3 lb. barrel, 1.5 lbs. in each 1.5 lb. barrel.) A variety of sizes will help make sure the grit is distributed evenly during each phase. Be sure to use rocks of similar hardness, as mixed hardnesses can lead to poor polish. (See [page 9](#))
4. **Add grit for coarse grind:** Add 3 Tbsp. of 60-90 silicon carbide grit for each 3 lb. barrel, 1.5 Tbsp. for each 1.5 lb. barrel.. Keep grit off the edge of the barrel where the inner lid will sit to ensure a leak-free seal.
5. **Add water to the barrel** until it just reaches the top layer of stones.
6. **Install the inner lid on the barrel:** Ensure that the inside lip of the barrel is clean and free of grit and stone chips, then install the inner lid. Make sure that the lid slides all the way down to the step inside the top lip of the barrel.

7. **Install the outer lid:** Put the top lid on the barrel, making sure that you push it down evenly all around the top edge of the barrel. Next, put the washer and the brass barrel nut on with the smooth part of the nut closest to the washer. Tighten the brass barrel nut by hand until secure. (Never use a tool to tighten the barrel nut!)
8. **Place the barrel onto the tumbler and align the barrel guide** into the slot on the barrel nut. This keeps the barrel in the proper position as the tumbler is running.

### Crooked, Off Center

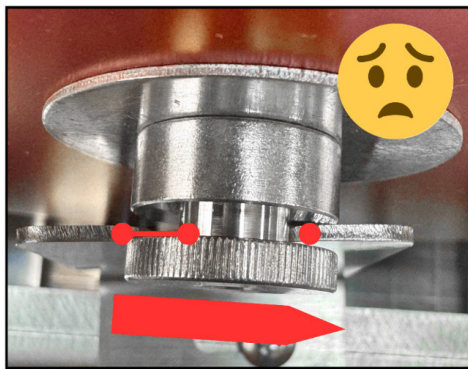

**NO**

### Straight, Centered

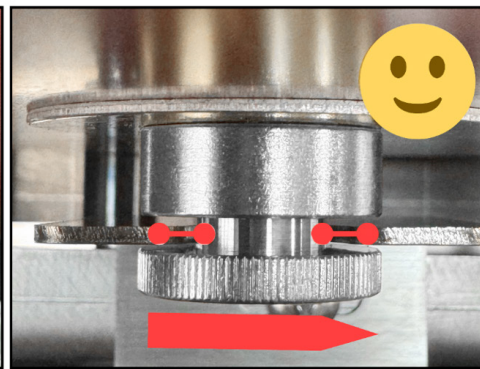

**YES**

9. **Coarse Grind process time:** Run the tumbler for 2-3 days, then open the barrels and check the stones to see that the edges are getting rounded and the stones are smooth. If the stones have not changed shape, add 1 Tbsp. additional grit. Reclose the barrel and run for an additional 3-4 days. Harder stones will take longer to get smooth than softer stones.
10. **Wash the stones** to prepare for the next grit! After the stones are nicely smoothed, open the barrel and drain the contents in a strainer over a bucket. **DO NOT** dump the water down the drain, because the grit and dirt in the water will clog the drain. Wash the stones, the barrel and the lid with soap and water to remove all traces of grit. Not doing so may contaminate your next step.
11. **Reload the barrel for Fine Grind:** Put the clean stones back in the barrel and add 3 Tbsp. of fine grit to the 3 lb barrel, or 1.5 Tbsp. (1.5 lb.) (Typically this can be 220 graded grit or 120/220 silicon carbide, which would be ungraded equivalent.) Since a certain amount of material has been removed from the stones, it is important now to add some type of media or stone to make up the difference so the barrel can be loaded to 3/4 again. Walnut shells, ceramic media or plastic pellets may be used. Add water like you did in step 5 (just until the water reaches the top layer of stones) then reclose the barrel. Run it for another 5-7 days, checking it again after 2-3 days. After completing this step, you should see the stones becoming much more smooth. When the stones are consistently smooth all over, then repeat the wash process (step 10) for cleaning the stones and the barrel and lid.

- 12. Reload the barrel for Pre-Polish:** Put the stones back in the barrel, adding media as required to get the barrel to 3/4 full. Add 4 Tbsp. of the pre-polish (3 lb.) or 2 Tbsp. (1.5 lbs.) (Typically this is 500 to 600 grit silicon carbide). Add water until it reaches the top layer of stones and media. Reclose the barrel and run for another 5-7 days, checking it again after 2-3 days. After completing this step, the stone will start to look much more shiny. When you can see that the surfaces of the stones are consistently shiny, then repeat the wash process (step 10) for cleaning the stones, barrel and lid.
- 13. Reload the barrel for Final Polish:** Put the stones back in the barrel with the appropriate amount of media to have the barrel 3/4 full. Add 4 Tbsp. (3 lb.) or 2 Tbsp. (1.5 lb.) of polish. (Depending on the stone, this is typically 2500 to 5000 grit aluminum oxide). Add water until it reaches the top layer of stones and media. Run the tumbler for another 5-7 days, checking it again after 2-3 days. After completing this step, the stones will look perfectly polished. When you can see that the surfaces of the stones are consistently shiny and bright, It's time to take them out of the tumbler! Repeat the process (step 10) for cleaning the stones, barrel and lid. You now have your first batch of finished tumbled stones!

## Maintaining Your Tumbler

Your Highland Park Model RT3L 3 lb. Rotary Tumbler has been designed to require minimal maintenance to keep polishing your treasures for years. To help it keep running smoothly, the *following regular maintenance is important*:



### Oiling the Shaft Bushings:

Oil the shaft bushings once each month using Lucas Gun Oil or Equivalent oil. Put only 1 drop in each bushing. Tilt the unit when applying the drop of oil to allow the oil to run into the bushing; it should lubricate the shaft inside the bushing.

### Cleaning the Barrel:

The barrel can be cleaned with soap and warm water both inside and outside. Do not use any solvents or try cleaning the barrel in the dishwasher, as these can damage the barrel. If the barrel becomes very smooth and slippery on the outside and begins to slip on the drive rollers (which could happen after extended use), the exterior can be roughed up a little by hand using some 400 grit sandpaper, which will allow it to grip the rollers better.

### **Motor, Controller and Fan:**

The motor and control system on your Highland Park Model RT3L 3 lb. Rotary Tumbler uses brushless DC motor technology. The motor and controller do not require any service, but you should routinely check to make sure that the fan is always functioning when the machine is running. If the fan is not operational when the machine is on, then the fan should be replaced.

### **General Cleaning:**

With use, your Highland Park Model RT3L 3 lb. Rotary Tumbler may get some dust and oil residue on it. Keeping your machine clean is a good way to keep it looking great and avoid issues like grit contamination. Unplug the tumbler before wiping it down. You can use a mild cleaning solution like 409 or Simple Green, but don't spray the cleaner directly on the machine. Instead, spray the solution on your cleaning rag, and then use the rag to wipe the surfaces of the machine.

### **Checking for Worn Parts:**

Your Model RT3L Rotary Tumbler is designed for long life and trouble-free service. However, with any machine there are components that will wear over time depending on the level of use. For your machine the following parts are considered wear parts:

**Barrel Inner Lid Gasket** – This is the most common wear part on 1.5 to 12 lbs rotary tumblers, the life of this part will be affected by the hardness and how sharp the stone that is being tumbled is. When this part is worn out, the barrel will begin to leak some. We recommend keeping an extra on hand.

**Guide Rail Rubber Sleeves** – The barrel rides on these rubber sleeves, which help allow the barrel to rotate without slipping. Over time, the sleeves may start to get grooves in them. If the barrel starts slipping, then it's time to replace them.

**Barrel** – The barrel will last a long time. However, it is considered a wear part because the rocks and grit rotating within the barrel will eventually wear down the wall thickness of the barrel with the abrasive tumbling action. When the barrel develops a hole, then it must be replaced.

**Barrel Nut** – The barrel nut rides in the guide bracket, protecting the barrel and keeping it from rubbing the machine frame. If the barrel guide is adjusted properly, then wear to the barrel nut is minimized. When the barrel nut flange wears off or becomes too difficult to tighten by hand, it should be replaced.

**Bushings** – There are four bushings that the main rails run on. Following the recommendation for periodic lubrication will allow these bushings to last a long time. However, if they become too loose and/or the barrel rotation becomes erratic, then it is time to replace them.

# Rock Tumbling Checklist

## COARSE GRIND

- Add rock to barrel - 3/4 full of small stones of assorted sizes.
- Add 3 Tbsp 60/90 silicon carbide grit to the barrel (3 lb.) OR 1.5 Tbsp. (1.5 lb.), keeping lip edge clean.
- Add water to barrel until it just reaches the top layer of stones.
- Install both lids and tighten brass nut by hand.
- Place barrel into the tumbler and align the barrel guide
- Run for 3-4 days total, or until stones are smooth.
- Check for progress after 2-3 days. If rocks are not changing, add 3 Tbsp. more grit
- Wash the stones, barrel and lid COMPLETELY before next grit.

## FINE GRIND

- Place stones in barrel. Fill with media until 3/4 full.
- Add 3 Tbsp 120/220 grit to the barrel (3 lb.) OR 1.5 Tbsp. (1.5 lb.).
- Add water until it just reaches the top layer of stones and media.
- Install both lids and tighten brass nut by hand.
- Place barrel into the tumbler and align the barrel guide.
- Check for progress after 2-3 days. If rocks are not changing, add 2 or 3 Tbsp. more grit.
- Run for 5-7 days.
- Wash the stones, barrel and lid COMPLETELY before next grit.

## PREPOLISH

- Reload barrel, adding media to get 3/4 full.
- Add 4 Tbsp. (3 lb.) or 2 Tbsp. (1.5 lb.) of 500-600 grit silicon carbide.
- Add water until it just reaches the top layer of stones and media.
- Install both lids. And tighten brass nut by hand.
- Place barrel into the tumbler and align the barrel guide.
- Run for another 5-7 days.
- Wash the stones, barrel and lid COMPLETELY before next grit.

## FINAL POLISH

- Reload barrel, adding media to get 3/4 full
- Add 4 Tbsp. (3 lb.) or 2 Tbsp. (1.5 lb.) of polish (typically 2500-5000 grit aluminum oxide)
- Add water until it just reaches the top layer of stones and media.
- Install both lids. (Tighten brass nut by hand.)
- Place barrel into the tumbler and align the barrel guide.
- Run for another 5-7 days.
- Clean the stones, barrel and lid. You now have your first batch of tumbled stones!

# A Quick Look At Rock Hardness

## ROCK TUMBLING GUIDE to HARDNESS

The Mohs Hardness Scale is the standard way geologists and lapidary enthusiasts refer to a rock's relative resistance to scratching. Tumbling rocks that have similar hardnesses is the only way to get a good polish, as harder stones will wear away softer stones, and the softer stones will leave a hazy surface on the harder stones. Beginners should consider starting with stones Mohs 7 or higher, as they are more likely to get good results. Rocks with a Mohs of less than 4 generally will not give you good results when tumbling.

The following is a short list of the types of stones that have each hardness. This is only a partial list. To determine the hardness of your rocks, you may want to purchase a hardness scratch test kit, available online.

- MOHS 10: Diamond
- MOHS 9: Corundum
- MOHS 8: Topaz, Emerald, Beryl
- MOHS 7: Agates, jaspers, petrified wood, quartz, tiger's eye, mookaite
- MOHS 6.5: Quartzite, flint, chert, jadeite, olivine, unakite, amazonite, basalt, aventurine,
- MOHS 6: Moonstone, feldspar, prehnite, diopside, rhodonite, nephrite, labradorite,
- MOHS 5-6: Dalmatian stone, opal, hematite, sodalite, obsidian, goldstone, lapis lazuli, turquoise, apatite
- MOHS 3.5-5: Magnesite, fluorite, dolomite, malachite, rhodochrosite, serpentine

# Rock Tumbling Chart

	Step 1	Step 2	Step 3	Step 4
COMPOUND	60/90 Silicon Carbide	120/220 Silicon Carbide	Pre-Polish Aluminum Oxide	Polish Aluminum Oxide
3 lb. Barrel	3 Tbsp.	3 Tbsp.	4 Tbsp.	4 Tbsp.
1.5 lb. Barrel	1.5 Tbsp.	1.5 Tbsp.	2 Tbsp.	1 Tbsp.

## Tumbler Speed

The Highland Park rotary tumblers are all designed to be variable speed, which gives the experienced tumbling artist the ability to accommodate different types of stone by adjusting the speed. To some degree, a faster speed can increase the smoothing of the stones, but running the tumbler too fast can create damage that is hard to clean up. . Running the tumbler faster than recommended speed should be done with caution.

For the Model RT 3.L, we recommend starting at a speed of 50 rpm. Tumbler speed should be adjusted so that you can't hear banging from the rocks inside - only a steady, rolling grind. The speed either can be set manually by putting a piece of tape on the barrel and counting revolutions by eye using a stopwatch, or by using a tachometer (see next section).

USING THE TACHOMETER (TA001) to Measure and Set the Speed:

To set the speed with the tachometer, cut a small square (approximately 3/8x3/8 inches) of the white sensor tape

(provided) and stick it to the edge of the lid rim. Rest the tachometer against the long side edge of the tumbler. The laser should be facing the rim with the tape. Hold the tachometer in one hand and use the other to adjust the potentiometer until the desired speed is achieved. (A video is available on the HP Lapidary Youtube channel).

*NOTE: On the earlier models of the tumbler, the external speed adjusting knob (potentiometer) is not present. To adjust the speed on those, look first at the side of the controller. There are two dip switches, one blue and one red. Both need to be in the up position. Then, adjust speed with the blue trim potentiometer while holding the tachometer steady, observing the speed of the tumbling barrel. A supplement to these instructions is available for download on the website, [www.hplapidary.com](http://www.hplapidary.com).*

## Common Tumbling Problems

### ***I FOLLOWED ALL THE STEPS, AND MY ROCKS ARE STILL HAZY!***

#### **Possible solutions:**

- Barrel cleaning between stages may not have been sufficient, contaminating the grit from one stage to the next. This will leave micro-scratches on the surface of the stones, which no amount of polishing will remove without going back to the previous grit. Be sure you clean rocks, barrel and lid until they are completely clean and free of grit.
- Tumbling rocks of varying stone hardnesses can make it more difficult to get a good polish. The softer stones wear against the harder ones, breaking down and making the polish less effective. Be sure the rocks you use have similar hardness values.
- A tumbler barrel that is less than 3/4 full will not polish as well as one that is loaded properly. As the rocks tumble down, be sure to use media such as ceramic or walnut shells to create a full load.

### ***MY EDGES (OR CENTERS, OR INDENTS) WON'T POLISH!***

#### **Possible solutions:**

**ONLY EDGES POLISHED** - Bring load up to 3/4 full so that the tumbling action of the rocks, media and grit can work properly

**ONLY CENTERS POLISHED** - Slurry is likely too thin. Return to the fine grind stage and repeat tumbling process

**INDENTS WON'T POLISH** - Add more small stones to the tumbling batch so that the grit will have a chance to work in the smaller areas. Return to prepolish stage.

### ***MY STONES ARE BREAKING IN THE MACHINE***

#### **Possible solutions:**

- Fractures that already exist in a stone will be stressed by the tumbling movement of the barrel. This may cause stones to break. In order to eliminate as much breakage as possible, inspect your tumbling stones carefully for fractures and breaks. Remember - garbage in, garbage out!
- Stones also may fracture if the tumbling speed is set too high. Be sure to set your tumbler to the proper tumbling speed, and make sure to decrease it with each polishing step.

# Warranty Coverage

## **Machines, Polishers, Diamond Blades & Core Bits and Motors**

Highland Park warrants to the original purchaser for a period of one year except as noted, from the date of purchase all products covered by this Warranty to be free of defects in materials and workmanship. This warranty is non-transferable and applies only to the original purchaser.

This Warranty shall not apply to any parts that have been subjected to misuse or improper service, that had been damaged in transit or handling, or that have been altered or repaired by unauthorized representatives. This Warranty does not cover defects caused by or resulting from misuse, abuse, neglect, or damage caused by accident or the failure to provide reasonable maintenance. This Warranty is void if the product or any of its individual components is altered or modified by the purchaser or if the product is used in a manner or with a blade not recommended by the manufacturer.

Any claim arising under this Warranty must be submitted by the original purchaser within the warranty period specified above and shall include proof of purchase. During said warranty period Highland Park shall, at its option, either replace or repair, at no charge to the original purchaser, any parts or components that are found to be defective by Highland Park. Highland Park shall not be responsible for or obligated to pay for freight or other transportation-related costs or expenses in connection with any defective products or components that are either returned to Highland Parks facility or any authorized repair station and/or any replacement products or components that are shipped from Highland Park pursuant to this Warranty.

Parts and labor needed to maintain products and the replacement of components due to normal use are the purchaser's responsibility and are not covered by this Warranty. All products or components replaced under warranty become the property of Highland Park. All replacement parts will be considered to be part of the original product and any warranty on such parts will expire coincidentally with the original Warranty. Replacement part(s) installed by anyone else will be provided without a charge for such replacement part(s), but this Warranty will not apply to labor charges in connection therewith.

***IN NO EVENT SHALL ANY LIABILITY UNDER THIS WARRANTY EXCEED THE REPLACEMENT COST OF ANY DEFECTIVE PRODUCT OR COMPONENT THEREOF, AND HIGHLAND PARK SHALL NOT BE LIABLE FOR ANY INCIDENTAL OR CONSEQUENTIAL DAMAGES OR FOR ANY OTHER DAMAGE OR LOSS NOT EXPRESSLY ASSUMED AS SET FORTH HEREIN.***

The foregoing constitutes an expressed warranty on the terms set forth above and is the only warranty or warranties applicable to the products it covers. All other warranties, including, without limitation, the implied warranty of merchantability and/or fitness for a particular purpose or use being denied. This limited warranty is expressly in lieu of all other warranties, whether expressed or implied.

# RT3L EXPLODED VIEWS

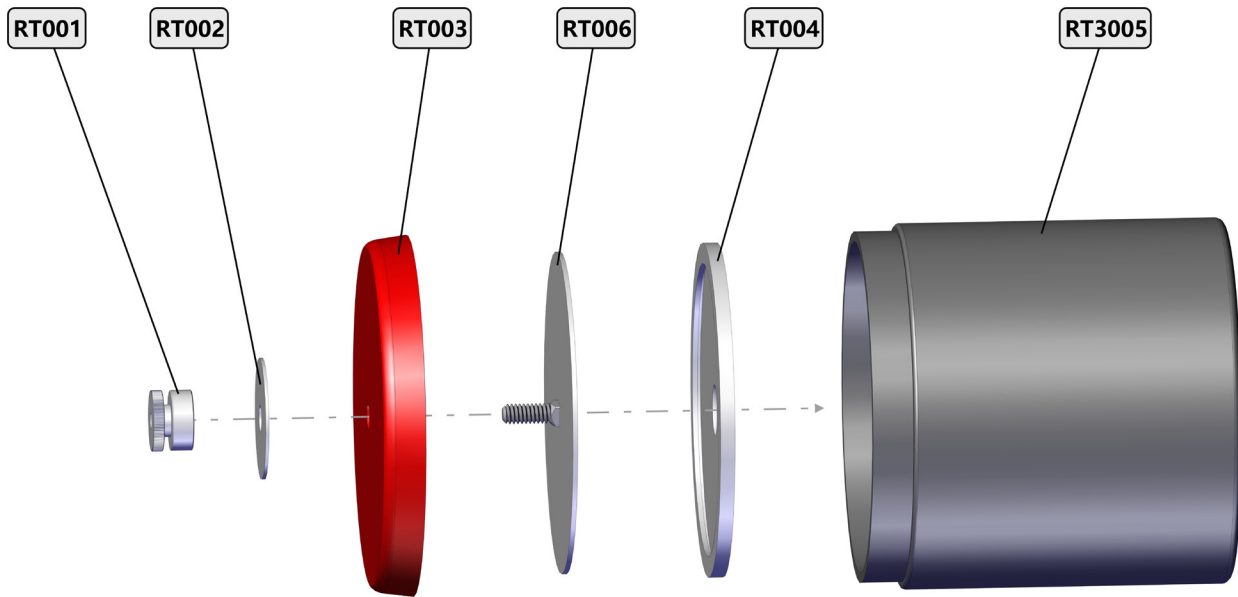

## RT 3L 3 LB. BARREL

Part Number	Description	Quantity
RT001	Rotary Tumbler Barrel Nut	1
RT002	Rotary Tumbler Barrel Washer	1
RT003	Barrel Outer Lid	1
RT004	Inner Lid Gasket	1
RT006	Inner Lid Assembly	1
RT3005	Rubber Barrel	1

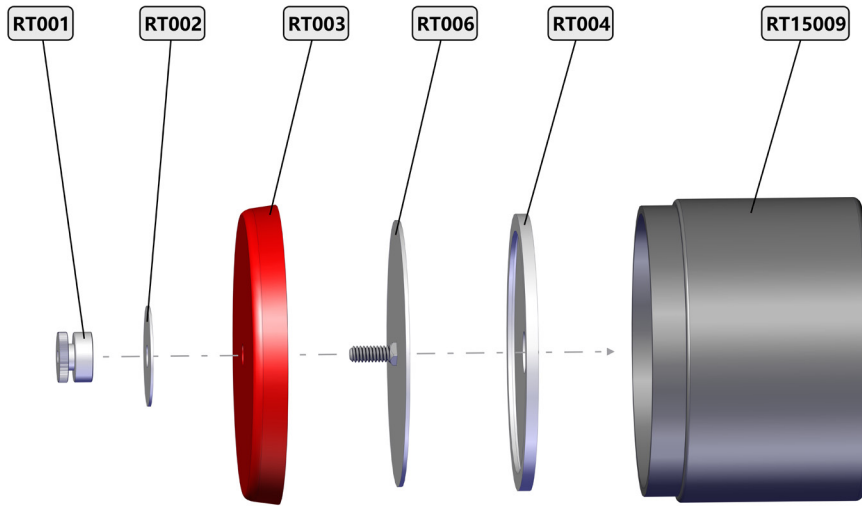

## RT 3L 1.5 LB. BARRELS

Part Number	Description	Quantity
RT001	Rotary Tumbler Barrel Nut	1
RT002	Rotary Tumbler Barrel Washer	1
RT003	Barrel Outer Lid	1
RT004	Inner Lid Gasket	1
RT006	Inner Lid Assembly	1
RT15009	RT1.5 Rubber Barrel	1

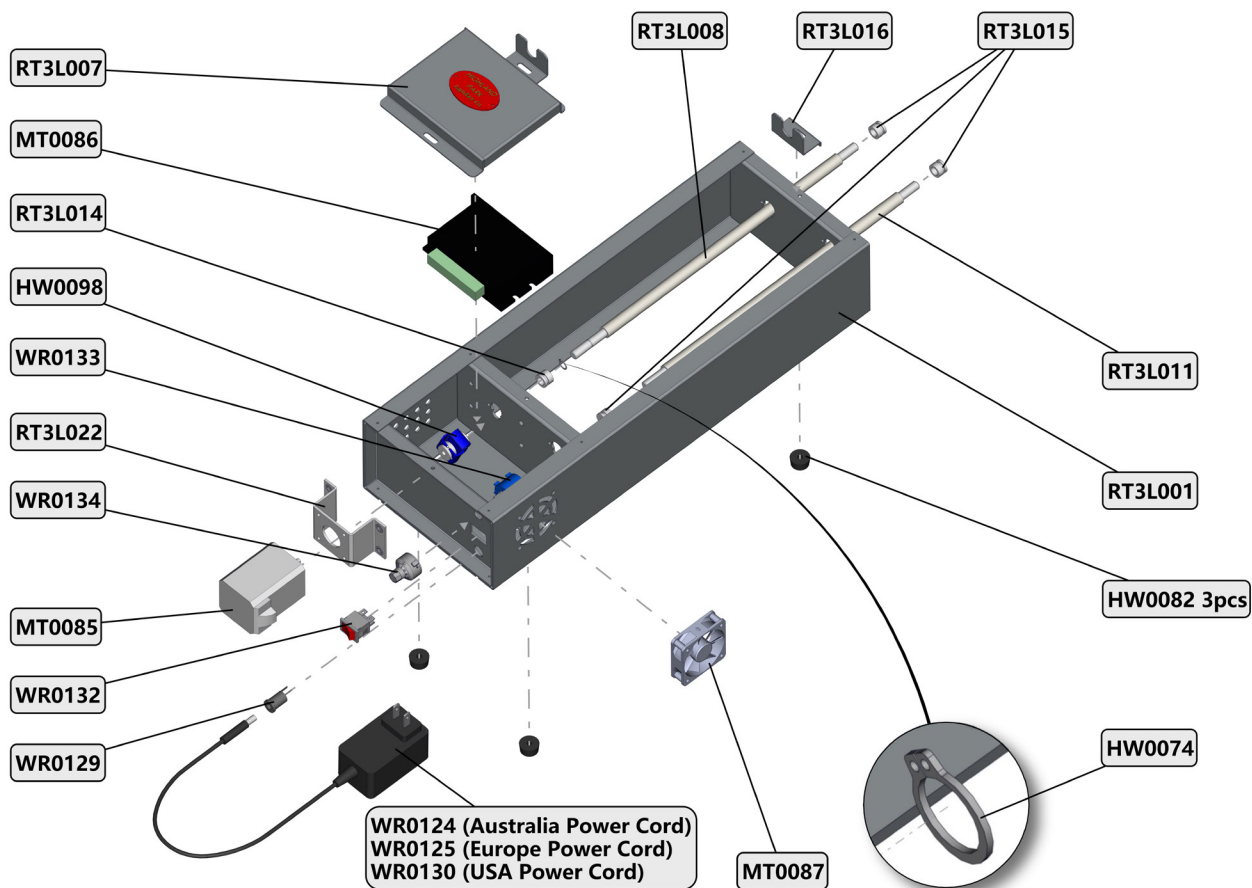

## MODEL RT3L MAIN COMPONENTS

Part Number	Description	Quantity
HW0074	External Retaining Ring	1
HW0082	Rubber feet	3
HW0098	Motor Drive Coupling	1
MT0085	24V Motor	1
MT0086	Brushless Motor Drive	1
MT0087	Cooling Fan	1
RT3L001	Body Assembly	1
RT3L007	Motor Cover	1
RT3L008	Drive Shaft Assembly	1
RT3L011	Idler Shaft Assembly	1
RT3L014	Open Bushing	1
RT3L015	Closed Bushing	3

RT3L016	Barrel Guide	1
RT3L022	Motor Mount Assembly	1
WR0124	Modular Power Supply 24VDC-2 Amp 110v-220V Australia	1
WR0125	Modular Power Supply 24VDC-2 Amp 110v-220V Europe	1
WR0129	Panel Mount Electrical Receptacle	1
WR0130	Modular Power Supply 24VDC-2 Amp 110v-220V USA	1
WR0132	Rocker Type Power Switch	1
WR0133	Ohm Potentiometer	1
WR0134	Potentiometer Turn Counter Knob	1

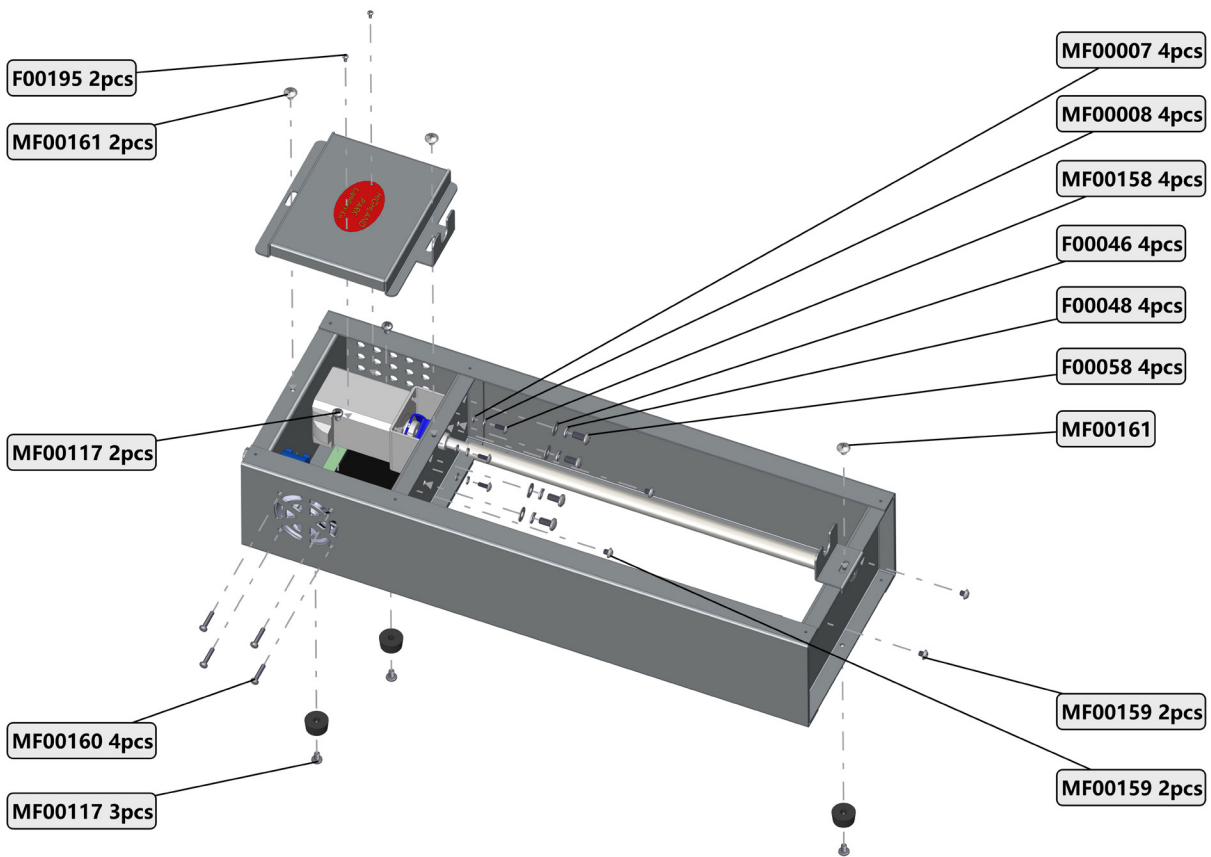

## MODEL RT3L SCREWS & FASTENERS

Part Number	Description	Quantity
F00046	10-32 Flat Washer	4
F00048	10-32 Lock Washer	4

F00058	10-32 x 3/8" PHP Pan Head Phillips	4
F00195	2-56 x 3/16" PHCS Brass Pan Head Phillips Screw	2
MF00007	M3-0.5 Flat Washer	4
MF00008	M3-0.5 Lock Washer	4
MF00117	M4-0.7 x 6mm PHP Pan Head Phillips Cap Screw	5
MF00158	M3-0.5 x 8mm PWHCS Phillips Head Cap Screw	4
MF00159	M4-0.7 x 4mm BHSCS Button Head Socket	4
MF00160	M3-0.5 x 16mm PHP Pan Head Phillips	4
MF00161	M4-0.7 x 6mm PWHP Pan Head Wide Phillips Cap Screw	3

## Troubleshooting

### TROUBLESHOOTING PROBLEMS WITH YOUR MACHINE

PROBLEM	CAUSE	SOLUTION
Barrel does not turn or slips	Barrel is slipping	Barrel is slippery and needs to be roughed slightly to grip drive sleeves better
	Rubber Drive Sleeve is slipping	Replace Drive Shaft
Tumbler Drive shaft is not turning	No Power to the unit	Check the wall outlet to be sure its working
	Power supply failure	Check the Power Supply to see if its outputting 24VDC, if no output then replace the Power Supply
	Drive Coupling is broken	Open the unit and inspect the drive coupling, if damaged then replace
Barrel Nut is rubbing and noisy/making powder	Barrel guide has a rough edge or burr	Use a nail file to smooth the edges of the barrel guide where the nut contacts it.
	Barrel guide is not adjusted properly	Using a phillips screwdriver, loosen the guide and adjust it so it's centered on the barrel nut and not on an angle then re-tighten the guide screws.

Barrel Leaking	Barrel lid is not installed correctly	Ensure that when the inner lid is installed all the way down to the inner step and that there is no grit or debris that will keep the inner lid gasket from sealing well
	Excess Gas is building up in the barrel during operation (certain stones may do this more than others)	Periodically open the barrel to vent excess gas. Note: The bottom of the barrel may start bulging as a sign of excess gas building in the barrel.
	Barrel Nut is improperly tightened	The barrel nut should never be tightened with any tools, only by hand.
	Barrel inner lid gasket is worn out.	Open the barrel and inspect the inner lid gasket for holes or tears, replace it if damaged.
	Barrel is worn out or damaged	Inspect barrel for wear or damage that prevents a proper seal

**ENJOY YOUR NEW HIGHLAND PARK LAPIDARY MODEL RT3L  
ROTARY ROCK TUMBLER! :)**

# Model RT3L: Rotary Tumbler Owner's Manual & Operating Instructions







[www.hplapidary.com](http://www.hplapidary.com)

## CONTACT US

[info@hplapidary.com](mailto:info@hplapidary.com)  
512-348-8528

## FOLLOW US

-  Highland Park Lapidary Co.
-  @hplapidary
-  Highland Park Lapidary
-  @highlandparklapidary

## LIFE'S TOO SHORT TO CUT UGLY ROCKS!

HIGHLAND PARK LAPIDARY  
**LIVE EVENTS**

Mondays, Wednesdays, Thursdays,  
Fridays and Saturdays  
Starts at 7:00 PM EST

